

Medos



www.medos.pl



PL

Grupa Medos zajmuje się produkcją akcesoriów do stolar-ki otworowej już od blisko 30 lat. Nasza pasja i zaangażowanie sprawia iż wciąż rozwijamy się i wprowadzamy coraz większą gamę produktów. Aktualnie na polskim rynku zaopatrujemy ponad 80% rodzimych producentów stolar-ki PCV i Aluminium, a nasze produk-ty znaleźć można w ponad 60 krajach Europy, Azji oraz Ameryki Północnej i Południowej.

Obecnie zatrudniamy blisko 600 osób. Trzon naszej produkcji stanowi nowoczesna odlewnia stopów aluminium oraz ZnAl, wtryskownia tworzyw sztucznych, malarnia proszkowa, galwanizernia, anodownia, tłocznia oraz obróbka mechaniczna stali i aluminium. Cały proces projektowania nowych produktów realizowany jest w naszej firmie, a wszystkie narzędzia wykonujemy we własnej narzędziowni.

Ciągłe poszukiwanie innowacyjnych rozwiązań i produktów, nowoczesna technologia, szybka realizacja zamówień, orientacja na klienta, profesjonalna i efektywna załoga, wysokie standardy i przy-wiązywanie uwagi do każdego szczegółu to fundament naszej firmy.

Dołącz do nas, razem otworzymy drzwi do sukcesu!

EN

Medos Group has been manufacturing accessories for doors and windows for almost 30 years. Our passion and commitment help us grow and introduce new range of products. Right now we supply more than 80% of Polish producers of PVC and aluminum, and our products can be found in more than 60 countries in Europe, Asia and South America.

Currently we employ around 600 people. The core of our production is a modern aluminum alloy and Zamak die casting foundries, plastic injection molding, powder coat- ing, galvanizing and anodizing plant, machine pressing and machining of steel and aluminum. The whole process of designing new products is undertaken in our company, and all of the tools are made in our own tool shop.

Continuous research for innovative solutions and products, modern technology, fast execution of orders, customer orientation, professional and efficient staff, high standards and meticulous attention to detail is the foundation that we build our company upon.

Join us, together we will open the door to success!

FR

Le Groupe Medos fabrique les accessoires pour menuiserie de porte et fenêtre déjà presque 30 ans. Notre passion et engagement nous font développer et introduire toujours de nouveaux produits. Actuellement, nous sommes fournisseur pour 80% de fabricants de menuiserie PVC et aluminium en Pologne et nos produits se vendent dans 60 pays en Europe, Asie, Amérique du Nord et du Sud.

En ce moment notre effectif compte plus de 600 salariés. Notre production est concentrée autour d'une fonderie d'alliages d'aluminium et de ZnAl moderne, des ateliers d'injection, de peinture à poudre, de galvanisation, d'anodisation, d'estampage, et d'usinage d'acier et d'aluminium. Le processus de conception de nouveaux produits est entièrement réalisé au sein de notre société.

Recherche constante de solutions et de produits innovants, technologie moderne, réalisation rapide de commandes, concentra- tion sur le client, équipe professionnelle et efficace, standards élevés et attachement aux détails – voilà les fondements de notre société.

Rejoignez-nous!

RU

ГК «Medos» занимается производством фурнитуры для окон и дверей уже почти 30 лет. Увлечение своим делом и оперативность действий помогают нам развиваться и вводить новую гамму продуктов. В данный момент мы снабжаем более 80% польских производителей окон и дверей из ПВХ и алюминия, а наши изделия можно найти в более 60 странах Европы, Азии, а также Северной и Южной Америки.

У нас работает более 600 человек. Основой нашего про- изводства являются современный литейный цех (производ- ство изделий из алюминия и сплава цинка), литейный цех по производству пластмассы, цех порошковой покраски, гальва- нический цех, цех по анодированию, пробивные прессы и механическая обработка стали и алюминия. Весь процесс от проектирования до внедрения новых изделий осуществляется в нашей фирме, а все пресс-формы выполняются в отделе по разработке и конструированию деталей.

Постоянный поиск инновационных решений и новых продуктов, современная технология, быстрая реализация заказов, ориентация на потребителя, профессиональный и эффективный коллектив, высокие стандарты обслуживания и внимание к деталям – это фундамент нашей фирмы.

Приглашаем к сотрудничеству, вместе мы откроем дверь к успеху!

Spis treści

Index / Table des matières / Содержание

Pochwyty ze stali nierdzewnej

INOX pull handles / Barre de tirage en INOX / Офисные ручки INOX

- 4-5 SS
- 6-7 SS9005S
- 8-9 SS z przyciskiem / with button / avec bouton / с кнопкой
- 10-11 PR
- 12-13 PR z przyciskiem / with button / avec bouton / с кнопкой
- 14-15 PR9005S
- 16-17 SS40
- 18-19 SS40M
- 20-21 SP
- 22-23 CS
- 24-25 MA
- 26-27 WB
- 28-29 CW
- 30-31 KW

Pochwyty aluminiowe

Aluminium pull handles / Barre de tirage en aluminium / Алюминиевые офисные ручки

- 32-33 Paris
- 34-35 Lisbon
- 36-37 Madrid
- 38-39 Prostokątny / Rectangular / Rectangulaire / Прямоугольная
- 40-41 Trójkątny / Triangular / Triangulaire / Треугольная
- 42-43 Prosty / Straight / Droit / Прямая
- 44-45 Owalny / Oval / Ovale / Овальная

46-47 Szyldy drzwiowe

Door rosette / Rosace / Накладка под цилиндр

Mocowania do pochwytów

Fixing sets / Ensembles de fixation / Крепежные наборы

- 48-49 ze stali nierdzewnej
Stainless steel / en INOX / из нержавеющей стали
- 50 aluminiowych
Aluminium / en aluminium / алюминиевых

Medos



SS

Pochwyty drzwiowy SS

Pull handle / Barre de tirage / Офисная ручка



-N°: 114SS30050045

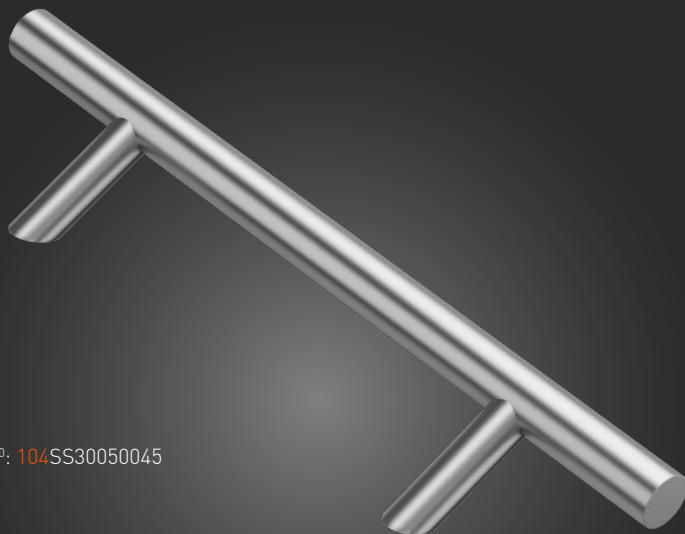

-N°: 104SS30050045

A	B
200	300
300	500
380	580
400	600
450	650
600	800
800	1000
1000	1200
1200	1400
1200	1600
1300	1800

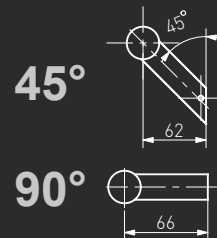
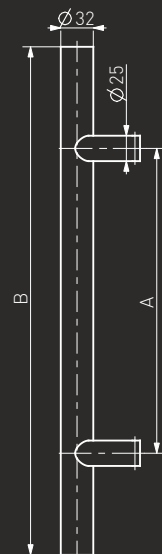
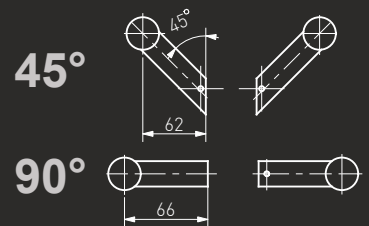
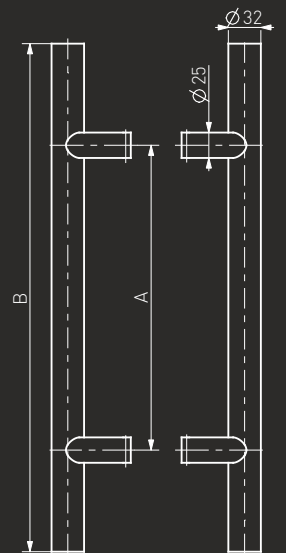

Wykończenie:

Finish / Finition / Покрытие

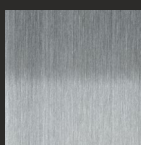

INOX

Stal nierdzewna

Stainless steel / Acier inoxidable / Нержавеющая сталь

Szczotkowana

Brushed / Brossée / Шлифованная



Pochwyty wymaga okresowej konserwacji
Pull handle requires periodic maintenance
Poignée de tirage exige une conservation régulière
Офисный ухват требует регулярного ухода



Dostępne w stali nierdzewnej 316
Available in 316 stainless steel
Disponible en acier inoxydable 316
Доступные в типе нержавеющей стали 316



Pochwyty na wymiar
Custom Sized Stainless Steel Pull Handles
Poignées de tirage inox sur mesure
Офисная ручка под размер

Medos



SS9005S



Pochwyty drzwiowy SS9005S

Pull handle / Barre de tirage / Офисная ручка



-N°: 2x 104SS300500459005



-N°: 104SS300500459005

A	B
300	500
380	580
600	800
800	1000
1000	1200
1200	1400
1300	1800

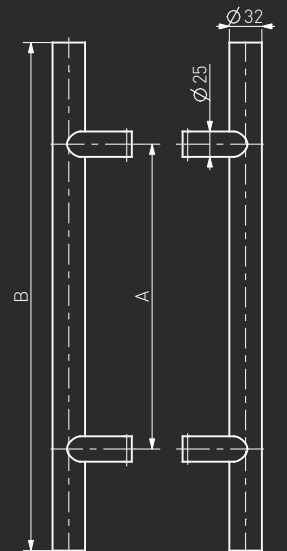

45°

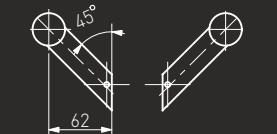

90°

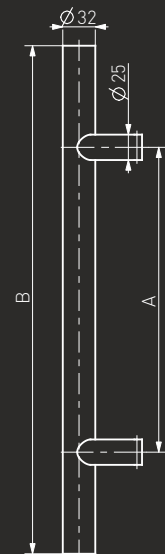
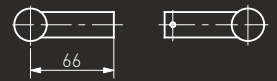

45°

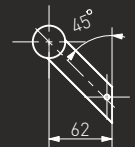

90°

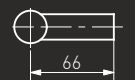

Wykończenie:

Finish / Finition / Покрытие



RAL9005S

Stal nierdzewna

Stainless steel / Acier inoxidable / Нержавеющая сталь

Malowane proszkowo

Powder coating / Laquage en poudre / Порошковая покраска



Pochwyty wymaga okresowej konserwacji
Pull handle requires periodic maintenance
Poignée de tirage exige une conservation régulière
Офисный ухват требует регулярного ухода

Medos



Pochwyty drzwiowy SS z przyciskiem

Pull handle with button / Barre de tirage avec bouton / Офисная ручка с кнопкой

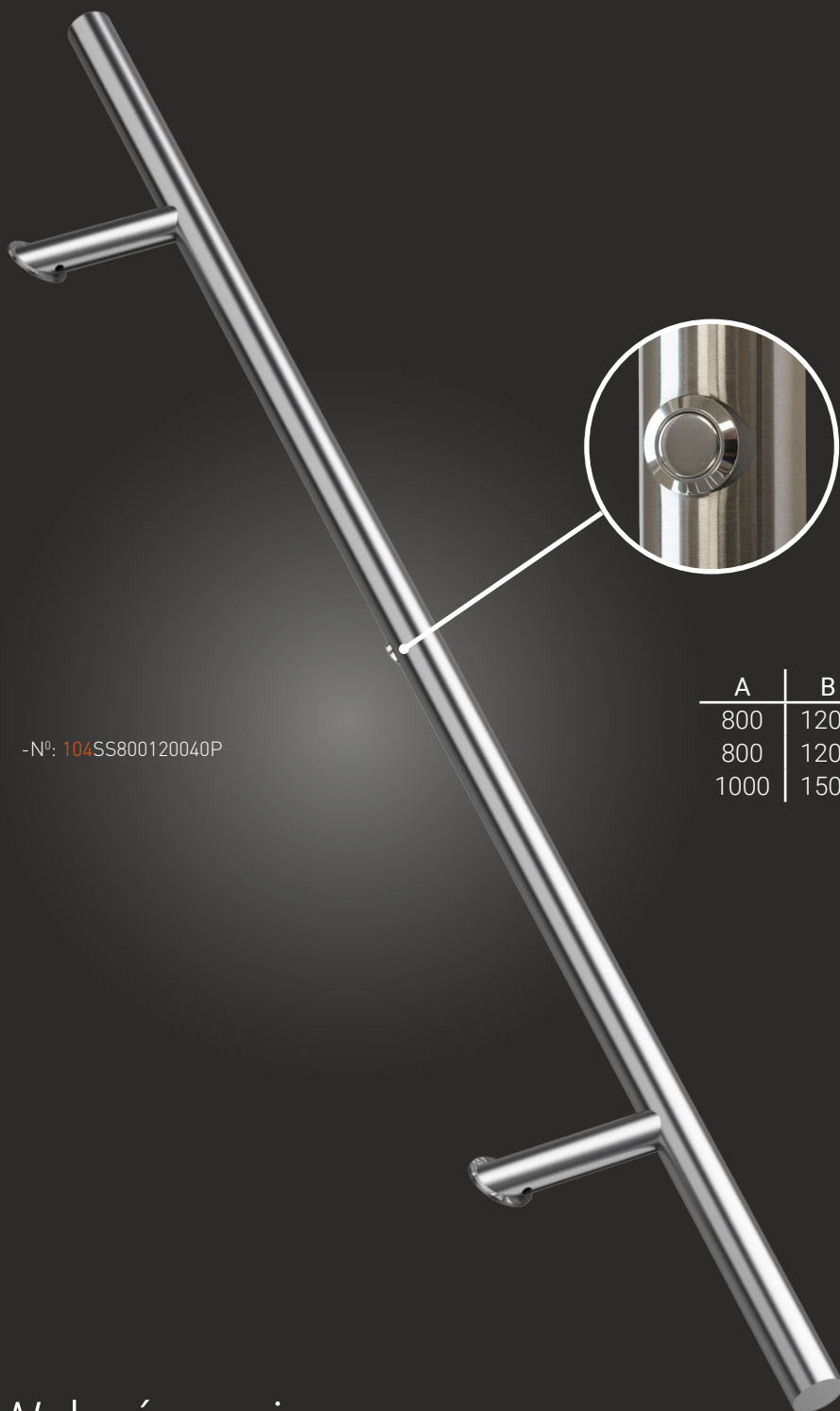

-N°: 104SS800120040P

A	B	∠
800	1200	40°
800	1200	90°
1000	1500	90°

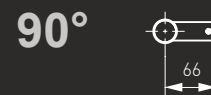
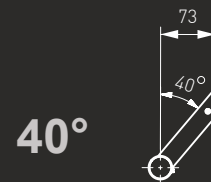
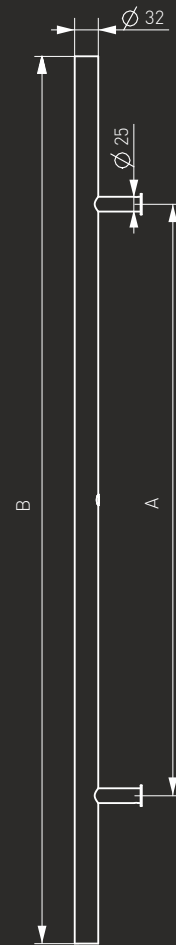

Wykończenie:

Finish / Finition / Покрытие

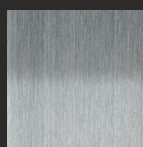

INOX

Stal nierdzewna

Stainless steel / Acier inoxidable / Нержавеющая сталь

Szczotkowana

Brushed / Brossée / Шлифованная



RAL9005S

Stal nierdzewna

Stainless steel / Acier inoxidable / Нержавеющая сталь

Malowane proszkowo

Powder coating / Laquage en poudre / Порошковая покраска



Pochwyty wymaga okresowej konserwacji
Pull handle requires periodic maintenance
Poignée de tirage exige une conservation régulière
Офисный ухват требует регулярного ухода

Medos



Pochwyt drzwiowy PR

Pull handle / Barre de tirage / Офисная ручка



-N°: 114PR30050045

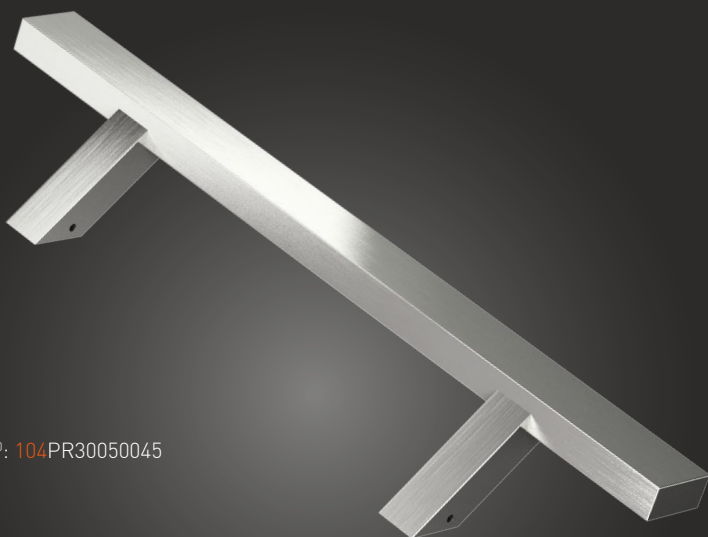

-N°: 104PR30050045

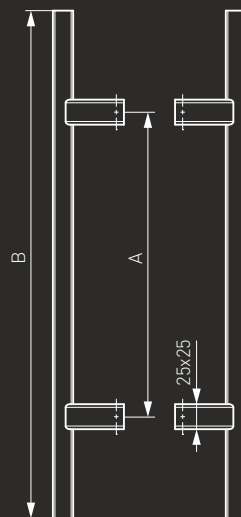

45°

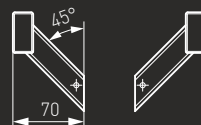

90°



A	B
300	500
450	650
600	800
800	1000
1000	1200
1200	1400
1200	1600
1300	1800

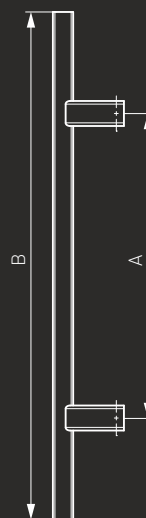

45°



90°



Wykończenie:

Finish / Finition / Покрытие



INOX

Stal nierdzewna

Stainless steel / Acier inoxidable / Нержавеющая сталь

Szczotkowana

Brushed / Brossée / Шлифованная



Pochwyt wymaga okresowej konserwacji
Pull handle requires periodic maintenance
Poignée de tirage exige une conservation régulière
Офисный ухват требует регулярного ухода



Pochwyt na wymiar
Custom Sized Stainless Steel Pull Handles
Poignées de tirage inox sur mesure
Офисная ручка под размер

Medos



PR9005S



Pochwyty drzwiowy PR9005S

Pull handle / Barre de tirage / Офисная ручка



-Nº: 2x 104PR300500459005



-Nº: 104PR300500459005

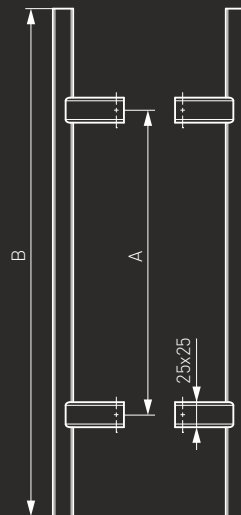

45°

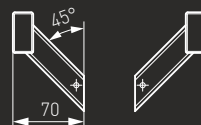

90°

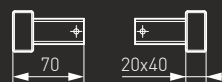

A	B
300	500
380	580
600	800
800	1000
1000	1200
1200	1400
1300	1800

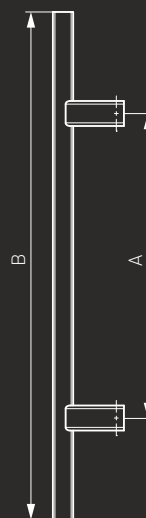

45°



90°



Wykończenie:

Finish / Finition / Покрытие



RAL9005S

Stal nierdzewna

Stainless steel / Acier inoxidable / Нержавеющая сталь

Malowane proszkowo

Powder coating / Laquage en poudre / Порошковая покраска



Pochwyty wymaga okresowej konserwacji
Pull handle requires periodic maintenance
Poignée de tirage exige une conservation régulière
Офисный ухват требует регулярного ухода

Medos



PR9005S

Pochwyt drzwiowy PR z przyciskiem

Pull handle with button / Barre de tirage avec bouton / Офисная ручка с кнопкой

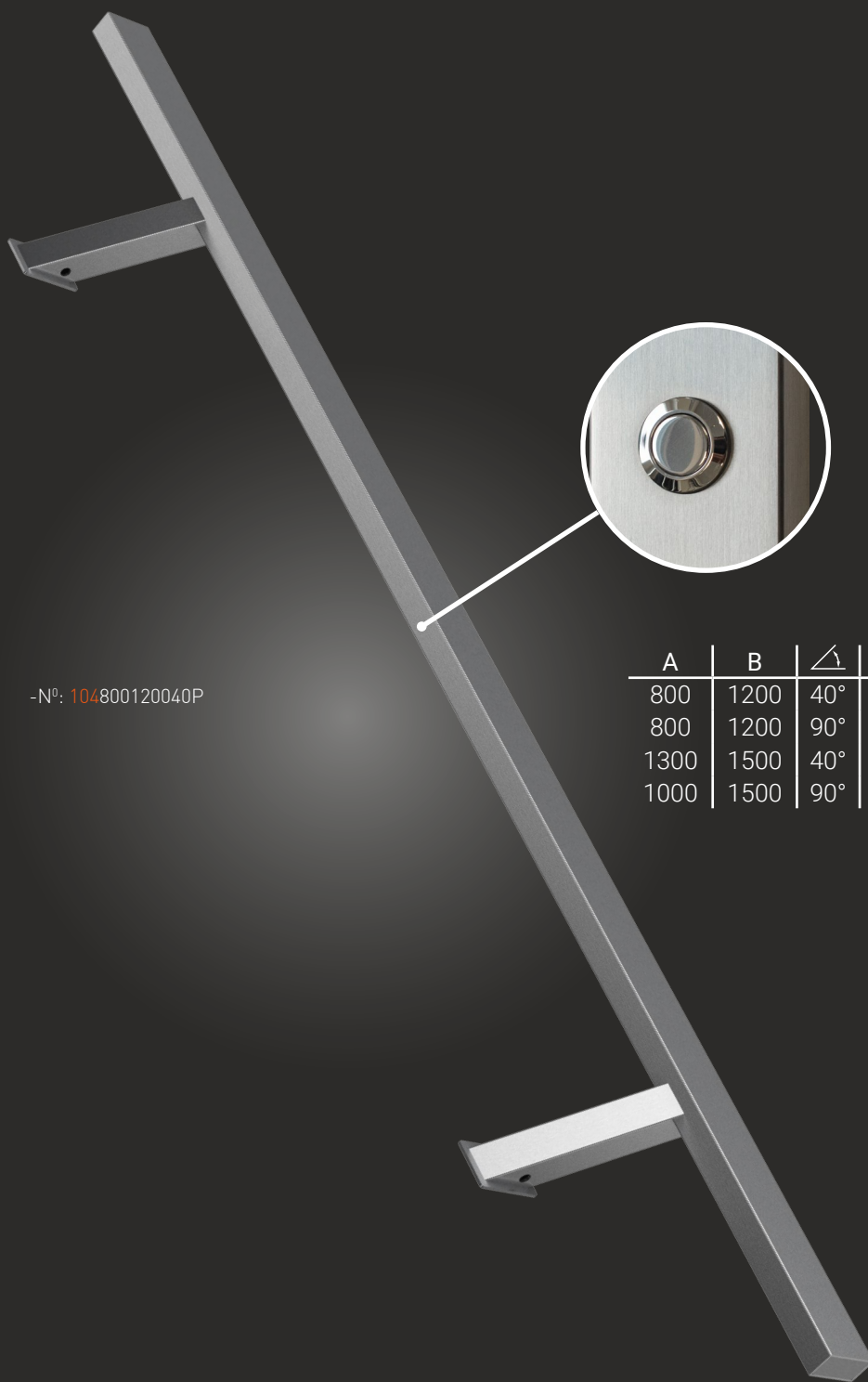

-Nº: 104800120040P

A	B	∠	🎨
800	1200	40°	INOX, RAL9005S
800	1200	90°	INOX, RAL9005S
1300	1500	40°	INOX, RAL9005S
1000	1500	90°	INOX

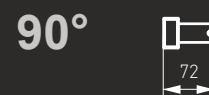
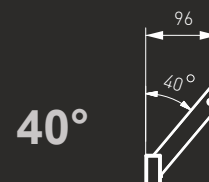
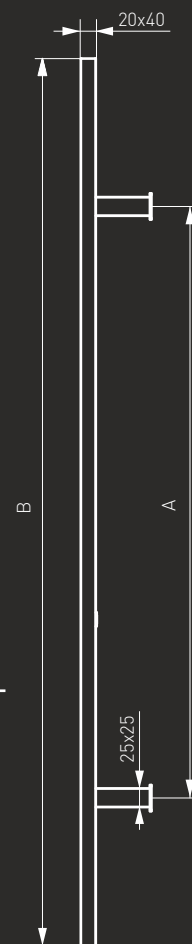

Wykończenie:

Finish / Finition / Покрытие

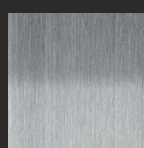

INOX

Stal nierdzewna

Stainless steel / Acier inoxidable / Нержавеющая сталь

Szczotkowana

Brushed / Brossée / Шлифованная

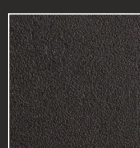

RAL9005S

Stal nierdzewna

Stainless steel / Acier inoxidable / Нержавеющая сталь

Malowane proszkowo

Powder coating / Laquage en poudre / Порошковая покраска



Pochwyt wymaga okresowej konserwacji
Pull handle requires periodic maintenance
Poignée de tirage exige une conservation régulière
Офисный ухват требует регулярного ухода

Medos



SS40

Pochwyty drzwiowy SS40

Pull handle / Barre de tirage / Офисная ручка



-N^o: 114SS401000120045

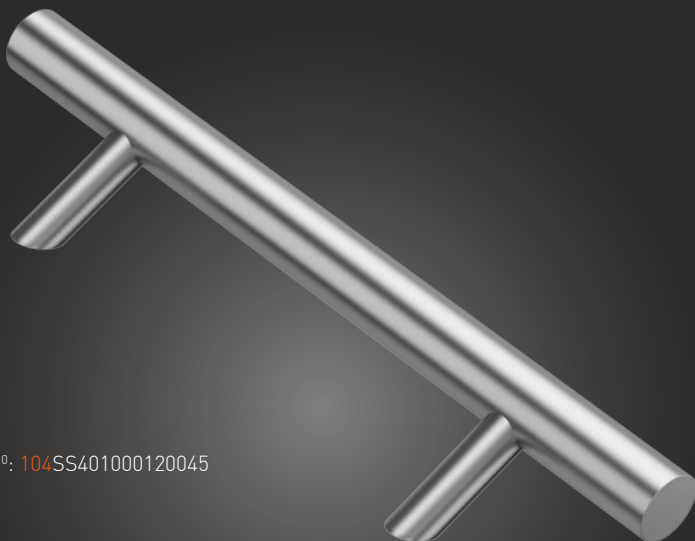

-N^o: 104SS401000120045

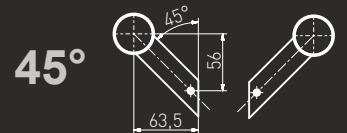
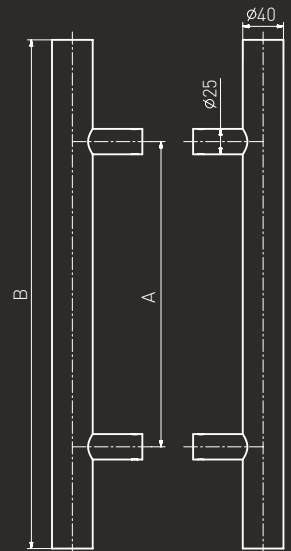

A	B
1000	1200
1200	1400
1200	1600
1300	1800
1800	2000
2000	2200

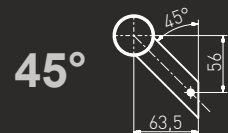
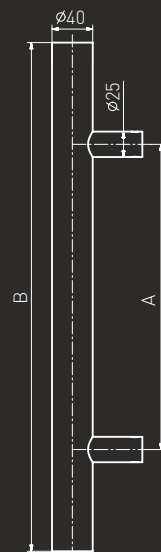

Wykończenie:

Finish / Finition / Покрытие

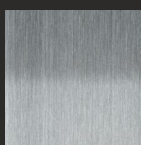

INOX

Stal nierdzewna

Stainless steel / Acier inoxidable / Нержавеющая сталь

Szczotkowana

Brushed / Brossée / Шлифованная



Pochwyty wymaga okresowej konserwacji
Pull handle requires periodic maintenance
Poignée de tirage exige une conservation régulière
Офисный ухват требует регулярного ухода



Pochwyty na wymiar
Custom Sized Stainless Steel Pull Handles
Poignées de tirage inox sur mesure
Офисная ручка под размер

Medos

SS40M

17



Pochwyty drzwiowy SS40M

Pull handle / Barre de tirage / Офисная ручка



-Nº: 2x 104SS40M206210090



-Nº: 104SS40M206210090

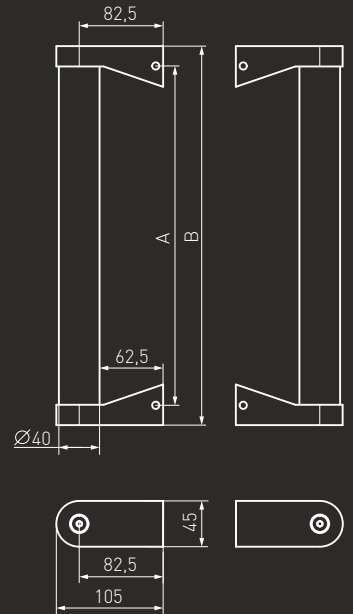

A	B
2061	2100
2261	2300
2461	2500
2661	2700

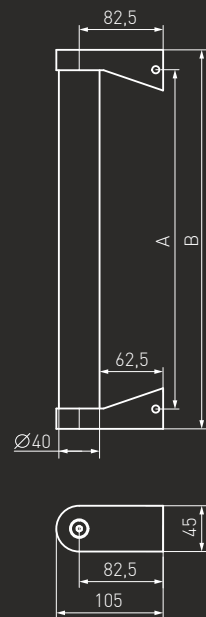

Wykończenie:

Finish / Finition / Покрытие

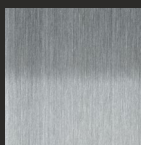

INOX

Stal nierdzewna

Stainless steel / Acier inoxidable / Нержавеющая сталь

Szczotkowana

Brushed / Brossée / Шлифованная



Pochwyty wymaga okresowej konserwacji
Pull handle requires periodic maintenance
Poignée de tirage exige une conservation régulière
Офисный ухват требует регулярного ухода



Instrukcja montażu
Assembly instruction
Instructions de montage
Инструкция по монтажу

Medos



SP

12



Pochwyty drzwiowy SP

Pull handle / Barre de tirage / Офисная ручка



-Nº: 114SP30050045

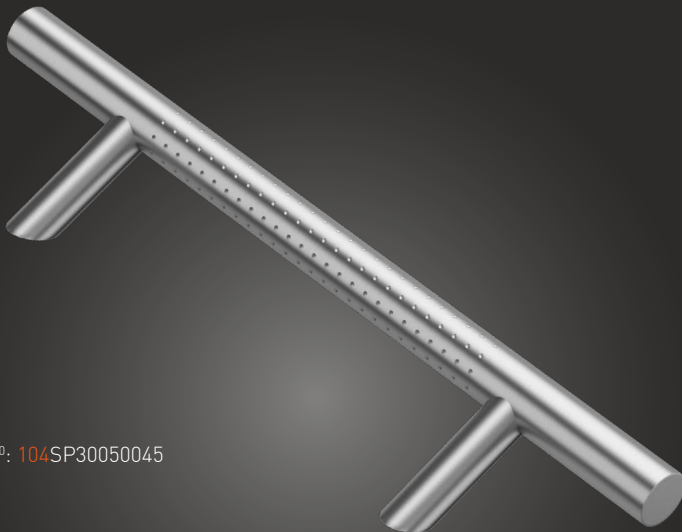

-Nº: 104SP30050045

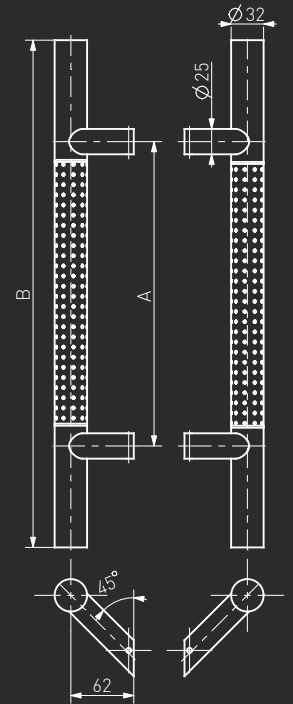

A	B
300	500
450	650
600	800
1200	1400

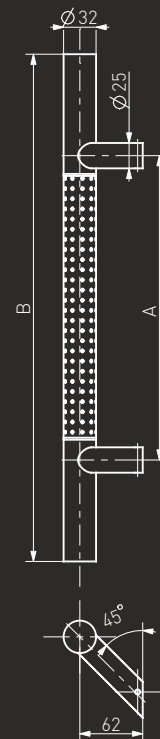

Wykończenie:

Finish / Finition / Покрытие

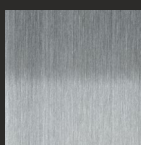

INOX

Stal nierdzewna

Stainless steel / Acier inoxidable / Нержавеющая сталь

Szczotkowana - Nakrapiana

Brushed - Spotted / Brossée - Pointillée / Шлифованная - С фрезерованной поверхностью в виде точек



Pochwyty wymaga okresowej konserwacji
Pull handle requires periodic maintenance
Poignée de tirage exige une conservation régulière
Офисный ухват требует регулярного ухода

Medos

CS



Pochwyt drzwiowy CS

Pull handle / Barre de tirage / Офисная ручка



-Nº: 114CS30050045

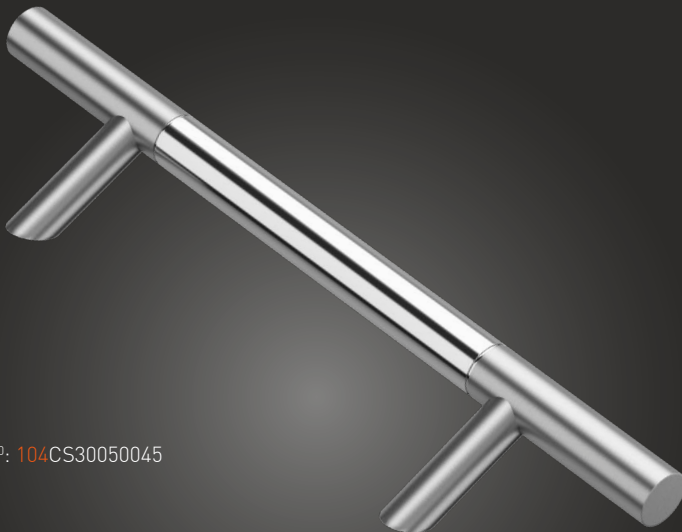

-Nº: 104CS30050045

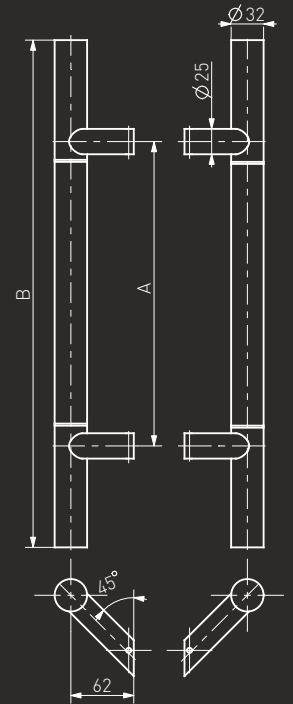

A	B
300	500
450	650
600	800
1200	1400

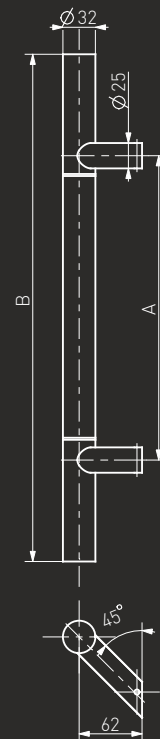

Wykończenie:

Finish / Finition / Покрытие

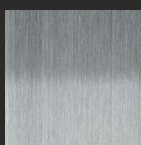

INOX

Stal nierdzewna

Stainless steel / Acier inoxidable / Нержавеющая сталь

Szczotkowana - Polerowana

Brushed - Polished / Brossée - Polie / Шлифованная - Полированная



Pochwyt wymaga okresowej konserwacji
Pull handle requires periodic maintenance
Poignée de tirage exige une conservation régulière
Офисный ухват требует регулярного ухода

Medos



MA

Pochwyty drzwiowy MA

Pull handle / Barre de tirage / Офисная ручка



-N°: 114MA30042245

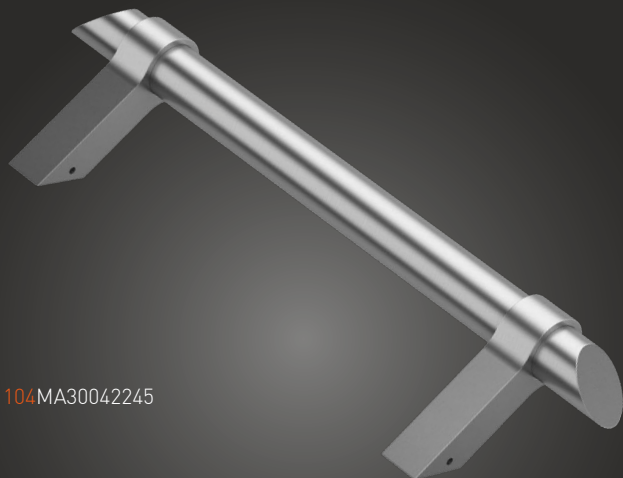

-N°: 104MA30042245

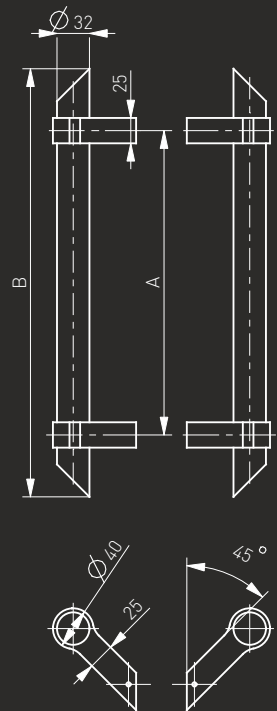

A	B
300	422
450	572
600	722
1200	1322

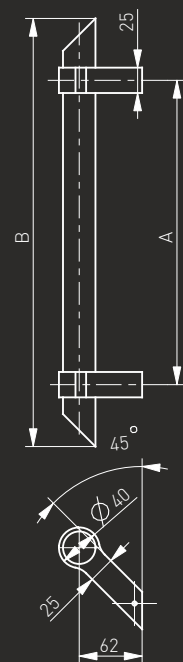

Wykończenie:

Finish / Finition / Покрытие

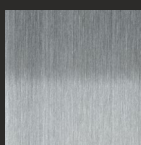

INOX

Stal nierdzewna

Stainless steel / Acier inoxidable / Нержавеющая сталь

Szczotkowana

Brushed / Brossée / Шлифованная



Pochwyty wymaga okresowej konserwacji
 Pull handle requires periodic maintenance
 Poignée de tirage exige une conservation régulière
 Офисный ухват требует регулярного ухода

Medos



WB



Pochwyty drzwiowy WB

Pull handle / Barre de tirage / Офисная ручка



-Nº: 2x 104WB30051945



-Nº: 104WB30051945

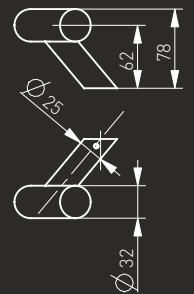
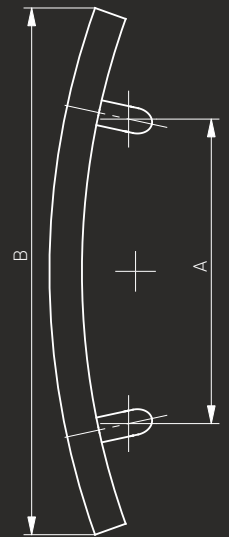

A	B
300	519
560	802

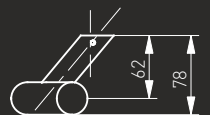
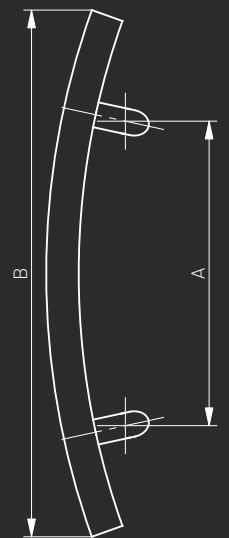

Wykończenie:

Finish / Finition / Покрытие

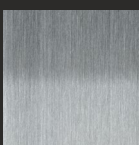

INOX

Stal nierdzewna

Stainless steel / Acier inoxidable / Нержавеющая сталь

Szczotkowana

Brushed / Brossée / Шлифованная



Pochwyty wymaga okresowej konserwacji
Pull handle requires periodic maintenance
Poignée de tirage exige une conservation régulière
Офисный ухват требует регулярного ухода

Medos

3



CW

Pochwyty drzwiowy CW

Pull handle / Barre de tirage / Офисная ручка

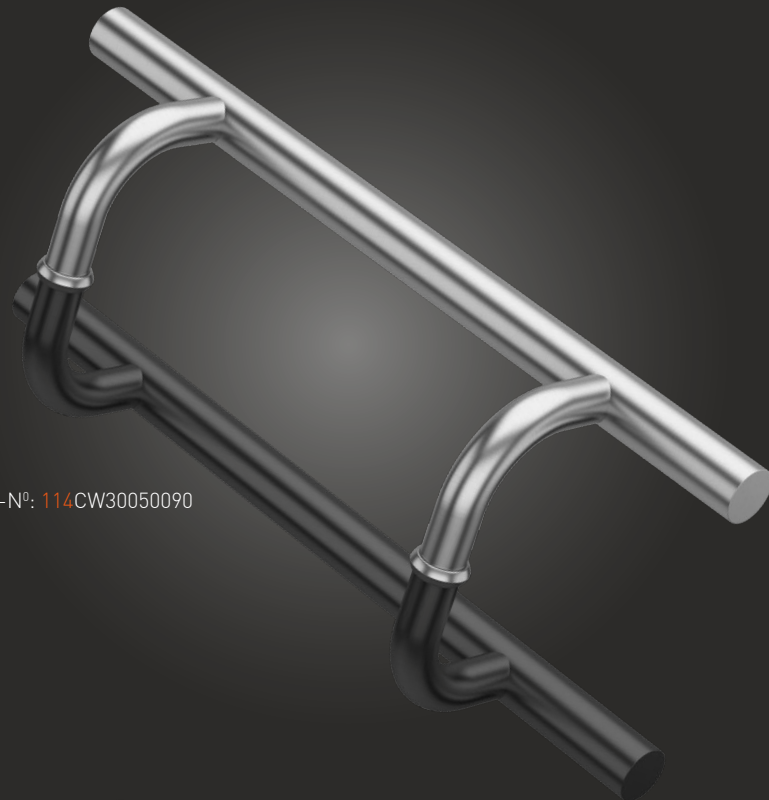

-N°: 114CW30050090



-N°: 104CW30050090

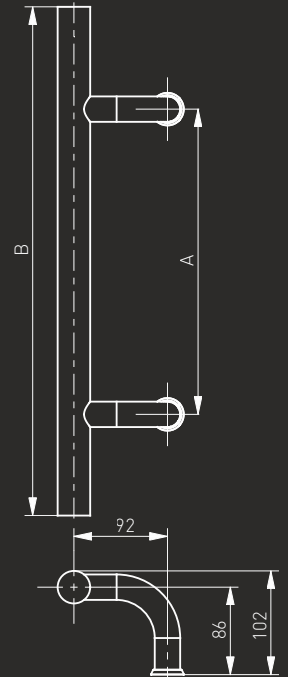

A	B
300	500
450	650
600	800
1200	1400
1300	1800

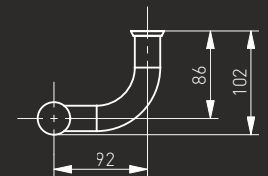
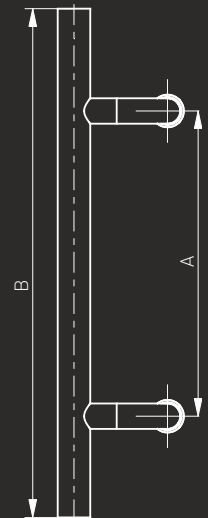
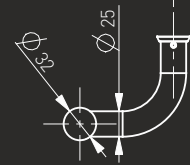

Wykończenie:

Finish / Finition / Покрытие

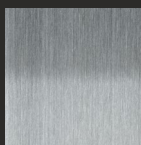

INOX

Stal nierdzewna

Stainless steel / Acier inoxidable / Нержавеющая сталь

Szczotkowana

Brushed / Brossée / Шлифованная



Pochwyty wymaga okresowej konserwacji
Pull handle requires periodic maintenance
Poignée de tirage exige une conservation régulière
Офисный ухват требует регулярного ухода

Medos

4

KW



Pochwyty drzwiowy KW

Pull handle / Barre de tirage / Офисная ручка



-N°: 114KW30050045

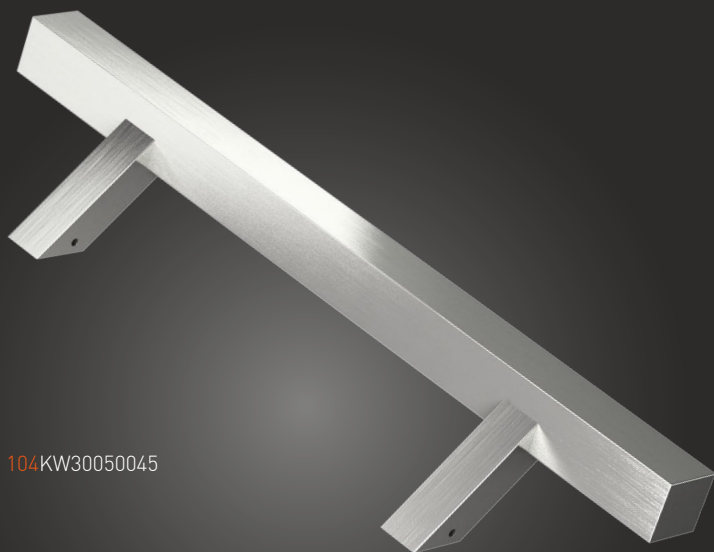

-N°: 104KW30050045

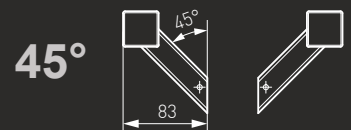
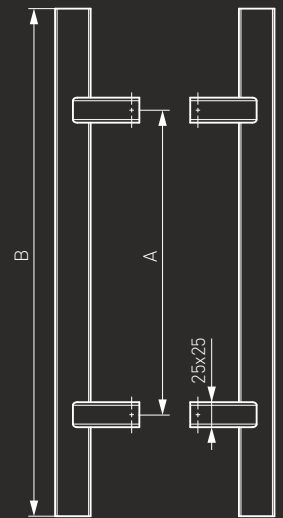

A	B
300	500
450	650
600	800
800	1000
1000	1200
1200	1400
1200	1600
1300	1800

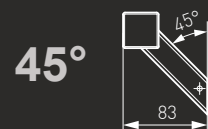
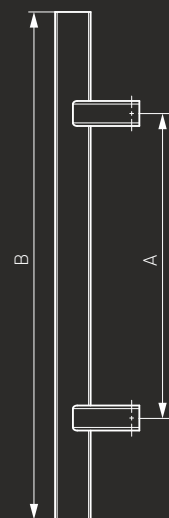

Wykończenie:

Finish / Finition / Покрытие

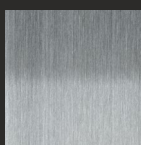

INOX

Stal nierdzewna

Stainless steel / Acier inoxidable / Нержавеющая сталь

Szczotkowana

Brushed / Brossée / Шлифованная



Pochwyty wymaga okresowej konserwacji
Pull handle requires periodic maintenance
Poignées de tirage exigent une conservation régulière
Офисный ухват требует регулярного ухода



Pochwyty na wymiar
Custom Sized Stainless Steel Pull Handles
Poignées de tirage inox sur mesure
Офисная ручка под размер

Medos

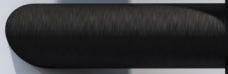

Paris

Pochwyt drzwiowy Paris

Pull handle / Barre de tirage / Офисная ручка



-Nº: 2x 104PF630050045B

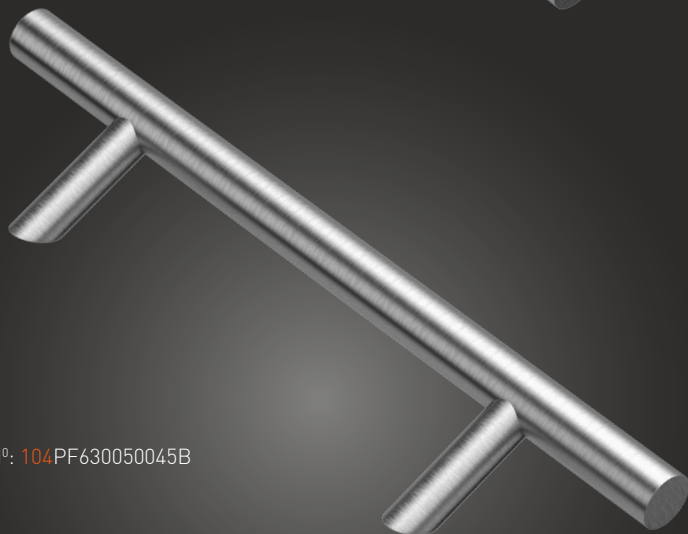

-Nº: 104PF630050045B

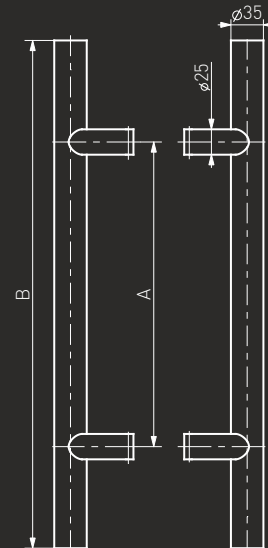

45°

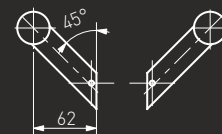

90°

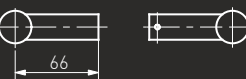

A	B	
300	500	*
450	650	*
500	800	
500	1000	
800	1200	
1000	1500	
1000	1700	

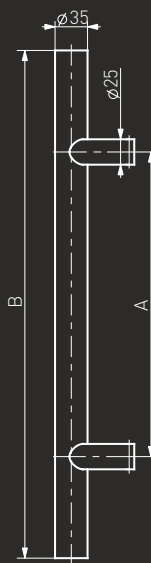

45°



90°

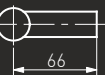

Wykończenie:

Finish / Finition / Покрытие



F6 - BD
(INOX)

F9005 - BD

F1 - BD*

F3 - BD*

F4 - BD*

Aluminium

Aluminum / Aluminium / Алюминий

Anodowane - Szczotkowane

Anodized - Brushed / Anodisation - Brossée / Анодирование - Шлифованная



Pochwyt wymaga okresowej konserwacji
Pull handle requires periodic maintenance
Poignée de tirage exige une conservation régulière
Офисный ухват требует регулярного ухода

* Oferta handlowa po konsultacji z przedstawicielem
* Commercial offer after consultation with representatives
* Offre commerciale après concertation avec le représentant
* Коммерческое предложение после консультации с представителем

Medos



Lisbon

Paris

Pochwyty drzwiowy **Lisbon**

Pull handle / Barre de tirage / Офисная ручка



-Nº: 2x 104LF630050045B

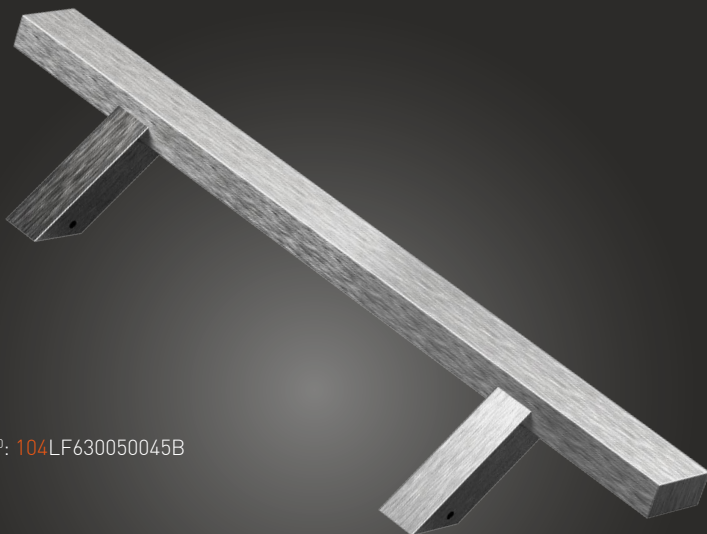

-Nº: 104LF630050045B

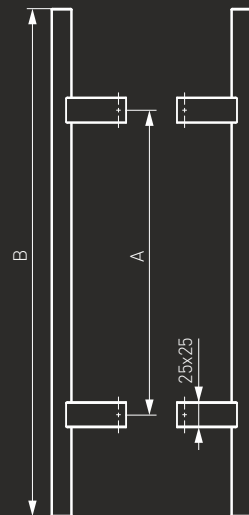

45°

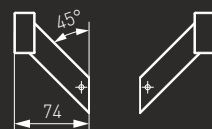

90°



A	B
300	500
450	650 *
500	800 *
500	1000
800	1200
1000	1500
1000	1700

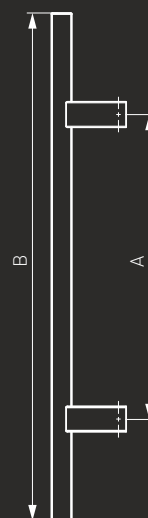

45°



90°



Wykończenie:

Finish / Finition / Покрытие

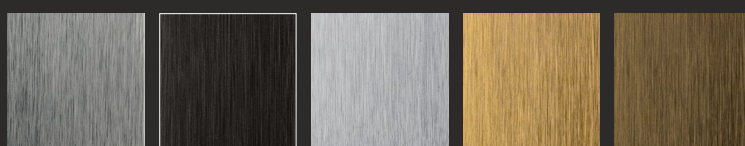

F6 - BD
(INOX)

F9005 - BD

F1 - BD*

F3 - BD*

F4 - BD*

Aluminium

Aluminum / Aluminium / Алюминий

Anodowane - Szczotkowane

Anodized - Brushed / Anodisation - Brossée / Анодирование - Шлифованная



Pochwyty wymaga okresowej konserwacji
Pull handle requires periodic maintenance
Poignée de tirage exige une conservation régulière
Офисный ухват требует регулярного ухода

* Oferta handlowa po konsultacji z przedstawicielem
* Commercial offer after consultation with representatives
* Offre commerciale après concertation avec le représentant
* Коммерческое предложение после консультации с представителем

Medos

Madrid



Pochwyty drzwiowy **Madrid**

Pull handle / Barre de tirage / Офисная ручка



-Nº: 2x 104MF630050045B

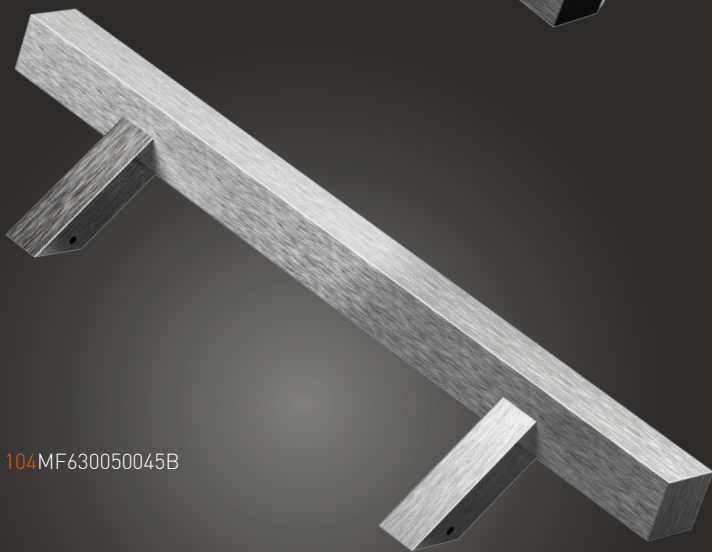

-Nº: 104MF630050045B

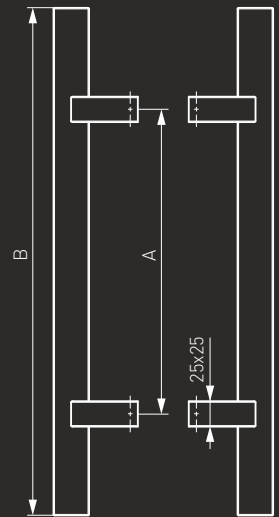

45°

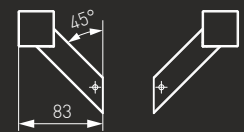

90°

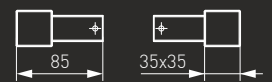

A	B	
300	500	*
450	650	*
500	800	*
500	1000	*
800	1200	*
1000	1500	*
1000	1700	*

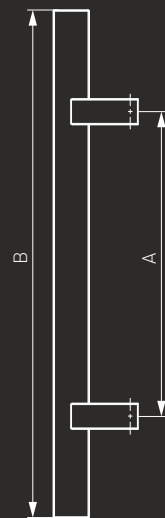

45°



90°



Wykończenie:

Finish / Finition / Покрытие



F6 - BD
(INOX)

F9005 - BD

F1 - BD*

F3 - BD*

F4 - BD*

Aluminium

Aluminum / Aluminium / Алюминий

Anodowane - Szczotkowane

Anodized - Brushed / Anodisation - Brossée / Анодирование - Шлифованная



Pochwyty wymaga okresowej konserwacji
Pull handle requires periodic maintenance
Poignée de tirage exige une conservation régulière
Офисный ухват требует регулярного ухода

* Oferta handlowa po konsultacji z przedstawicielem
* Commercial offer after consultation with representatives
* Offre commerciale après concertation avec le représentant
* Коммерческое предложение после консультации с представителем

Medos



Prostokątny

IV



Pochwyt drzwiowy Prostokątny

Pull handle / Barre de tirage / Офисная ручка



-Nº: 114SILV3001



-Nº: 104SILV3001

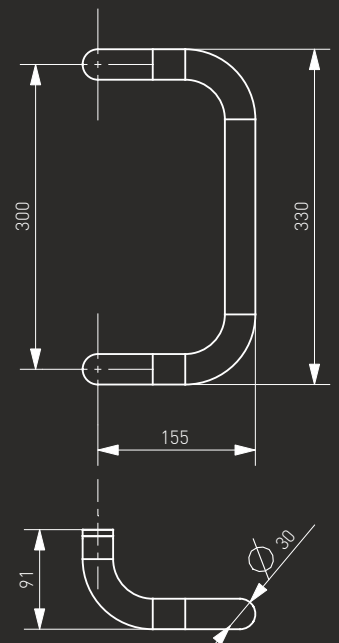
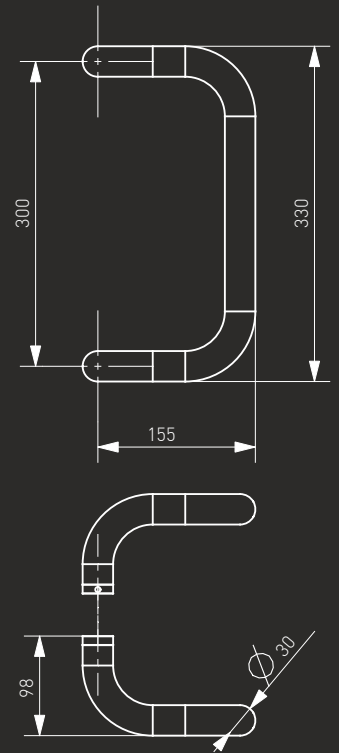

Wykończenie:

Finish / Finition / Покрытие

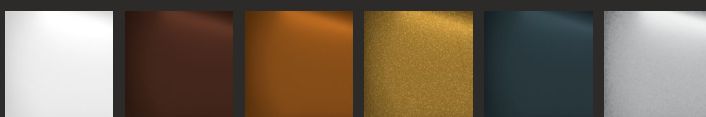

RAL 9016

RAL 8017

RAL 8003

GOLD

RAL 7016
MAT

Surowy
Mill finish

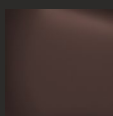

RAL 8019

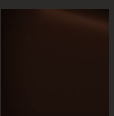

RAL 8077



RAL 9005
MAT

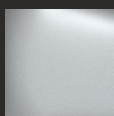

SILVER

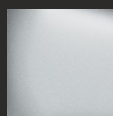

RAL 9006
MAT

Aluminium

Aluminum / Aluminium / Алюминий

Malowane proszkowo

Powder coating / Laquage en poudre / Порошковая покраска

Medos

Trojkatny



Pochwyt drzwiowy Trójkątny

Pull handle / Barre de tirage / Офисная ручка



-Nº: 114SILV3002

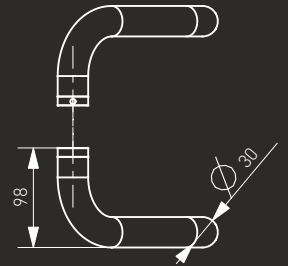
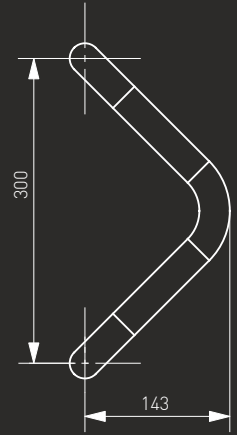

-Nº: 104SILV3002

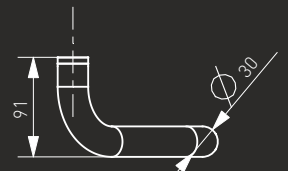
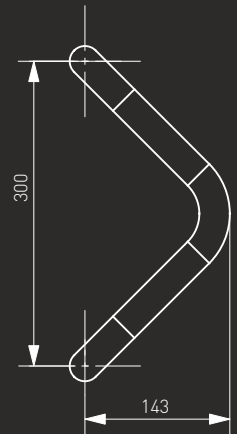

Wykończenie:

Finish / Finition / Покрытие

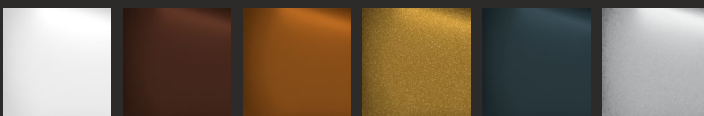

RAL 9016

RAL 8017

RAL 8003

GOLD

RAL 7016
MAT

Surowy
Mill finish

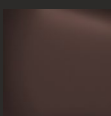

RAL 8019

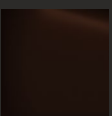

RAL 8077

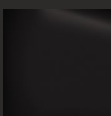

RAL 9005
MAT

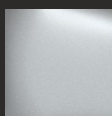

SILVER

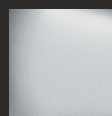

RAL 9006
MAT

Aluminium

Aluminum / Aluminium / Алюминий

Malowane proszkowo

Powder coating / Laquage en poudre / Порошковая покраска

Medos

V

Prosty



Pochwyt drzwiowy Prosty

Pull handle / Barre de tirage / Офисная ручка

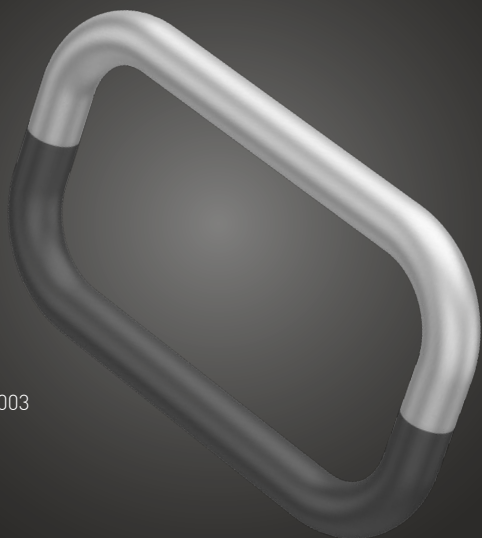

-Nº: 114SILV3003

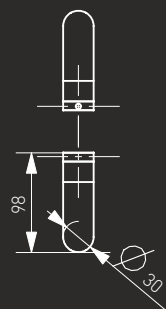
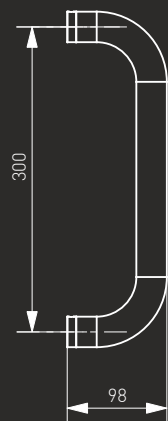

-Nº: 104SILV3003

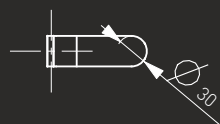
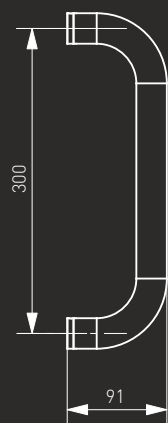

Wykończenie:

Finish / Finition / Покрытие

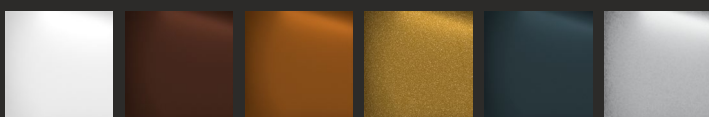

RAL 9016

RAL 8017

RAL 8003

GOLD

RAL 7016

MAT

Surowy

Mill finish

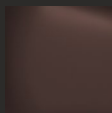

RAL 8019

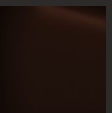

RAL 8077

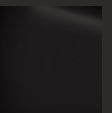

RAL 9005

MAT

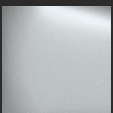

SILVER

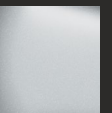

RAL 9006

MAT

Aluminium

Aluminum / Aluminium / Алюминий

Malowane proszkowo

Powder coating / Laquage en poudre / Порошковая покраска

Medos

Owalny



Pochwyt drzwiowy **Owalny**

Pull handle / Barre de tirage / Офисная ручка



-Nº: 114SILV3004

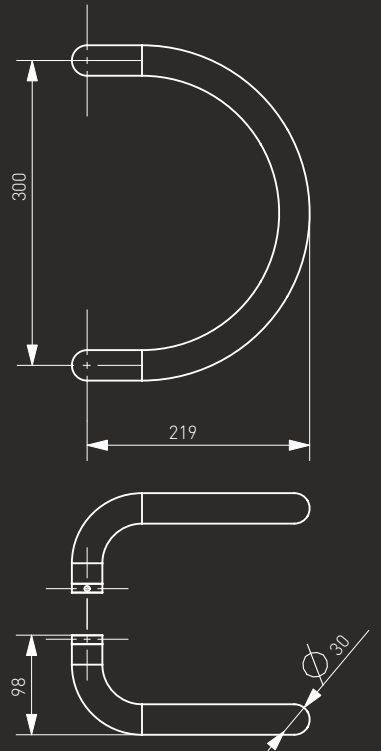

-Nº: 104SILV3004

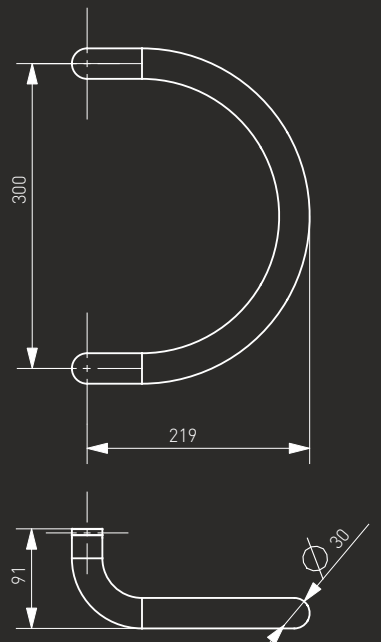

Wykończenie:

Finish / Finition / Покрытие

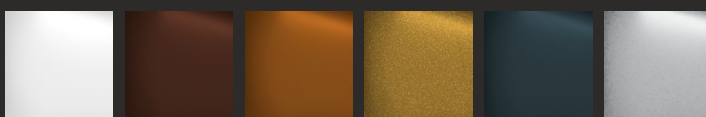

RAL 9016

RAL 8017

RAL 8003

GOLD

RAL 7016
MAT

Surowy
Mill finish

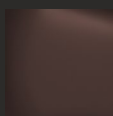

RAL 8019

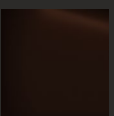

RAL 8077



RAL 9005
MAT

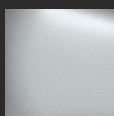

SILVER

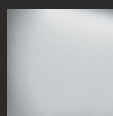

RAL 9006
MAT

Aluminium

Aluminum / Aluminium / Алюминий

Malowane proszkowo

Powder coating / Laquage en poudre
/ Порошковая покраска

Szyld drzwiowy Sofia

Door rosette / Rosace / Накладка под цилиндр

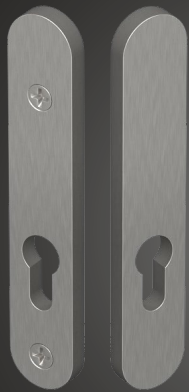

Sofia

-N^o: 50S292F6BWS



Sofia+

-N^o: 60SPPLUS2F6BWS

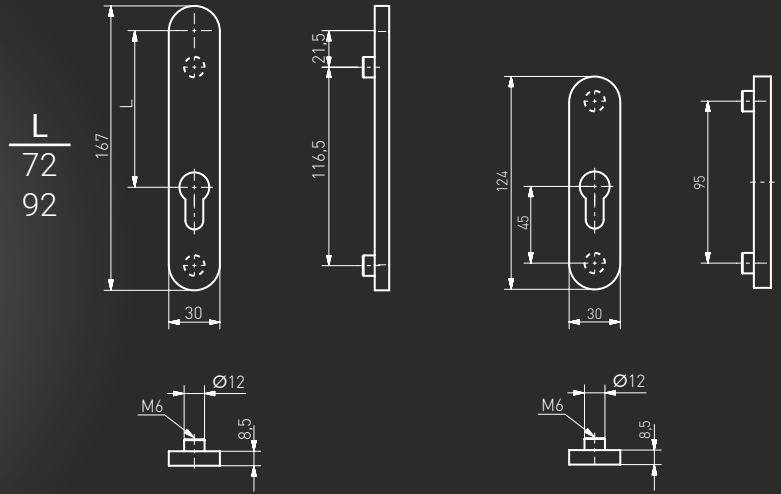

Szyld drzwiowy Riga

Door rosette / Rosace / Накладка под цилиндр

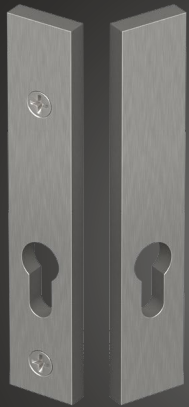

Riga

-N^o: 70R292F6BWS



Riga+

-N^o: 80RPLUS2F6BWS

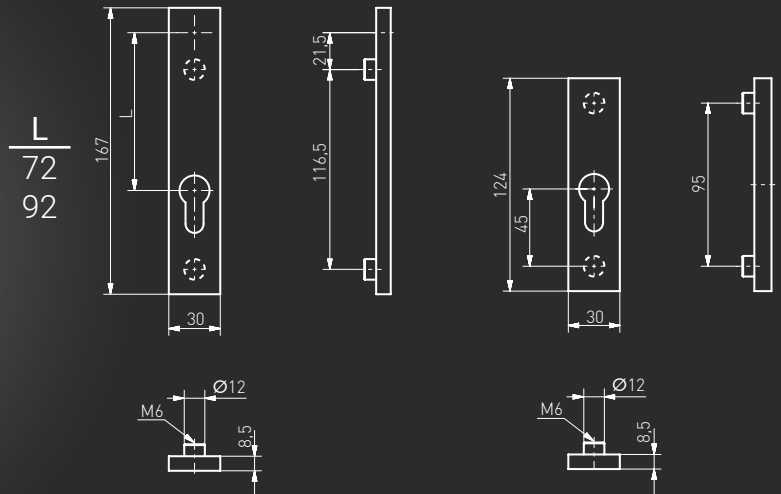

Wykończenie:

Finish / Finition / Покрытие



F6 - BD
(INOX)

F9005 - BD

F1 - BD*

F3 - BD*

F4 - BD*

Aluminium

Aluminum / Aluminium / Алюминий

Anodowane - Szczotkowane

Anodized - Brushed / Anodisation - Brossée / Анодирование - Шлифованная

* Oferta handlowa po konsultacji z przedstawicielem
 * Commercial offer after consultation with representatives
 * Offre commerciale après concertation avec le représentant
 * Коммерческое предложение после консультации с представителем

Szyld drzwiowy **Owalny**

Door rosette / Rosace / Накладка под цилиндр



-Nº: 151SILV0000

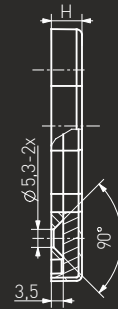
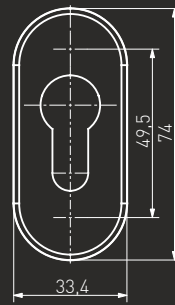

H	🌀
6,5	INOX
9	RAL, INOX

Szyld drzwiowy **Prostokątny**

Door rosette / Rosace / Накладка под цилиндр



-Nº: 150SILV0000

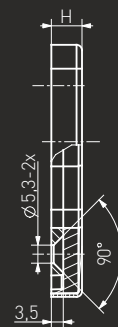
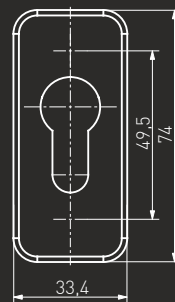

Wykończenie:

Finish / Finition / Покрытие

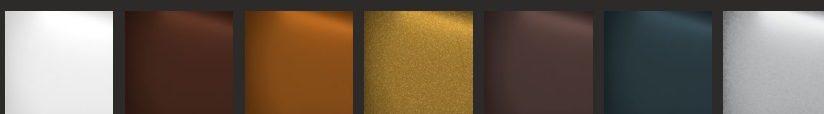

RAL 9016

RAL 8017

RAL 8003

GOLD

RAL 8019

RAL 7016

MAT

Surowy
Mill finish

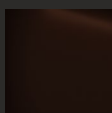

RAL 8077

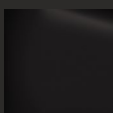

RAL 9005
MAT

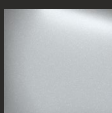

SILVER

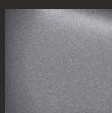

TITAN

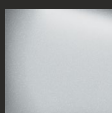

RAL 9006
MAT

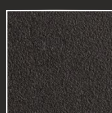

RAL 9005S

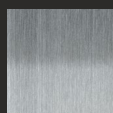

INOX

Aluminium

Aluminum / Aluminium / Алюминий

Malowane proszkowo

Powder coating / Laquage en poudre / Порошковая покраска

Stal nierdzewna

Stainless steel / Acier inoxidable / Нержавеющая сталь

Szczotkowana

Brushed / Brossée / Шлифованная

Mocowania do pochwytów ze stali nierdzewnej

Stainless steel pull handles fixing sets / Kit de fixation pour les barres de tirage en INOX / Крепление для ручек из нержавеющей стали

Mocowanie na płytce Fixing set Fixation Крепление	Opis Description Description Описание	Index -N°	Rys. techniczny Technical drawing Fiche technique Чертеж
	<p>INOX O-90</p> <p>Obsługiwane pochwyt Compatible models Barres de tirage prises en charge Подходит для ручек SS / CW</p> <p>Kąt mocowania Mounting angle Position de montage Угол крепления 90°</p>	<p>ALU 10409002</p>	
	<p>INOX O-45</p> <p>Obsługiwane pochwyt Compatible models Barres de tirage prises en charge Подходит для ручек SS / SP / CS / WB</p> <p>Kąt mocowania Mounting angle Position de montage Угол крепления 45°</p>	<p>ALU 10404502</p>	
	<p>INOX KP-90</p> <p>Obsługiwane pochwyt Compatible models Barres de tirage prises en charge Подходит для ручек KW / PR</p> <p>Kąt mocowania Mounting angle Position de montage Угол крепления 90°</p>	<p>ALU 104KP9002</p>	
	<p>INOX KP-45</p> <p>Obsługiwane pochwyt Compatible models Barres de tirage prises en charge Подходит для ручек KW / PR / SE / MA</p> <p>Kąt mocowania Mounting angle Position de montage Угол крепления 45°</p>	<p>ALU 104KP4502</p>	



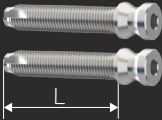
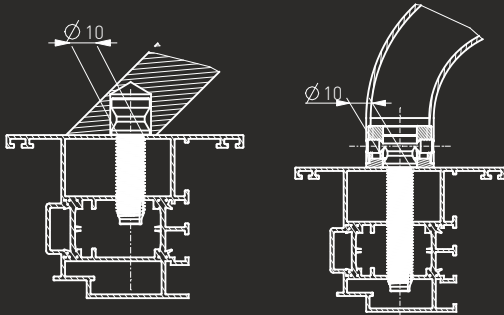
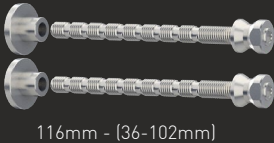
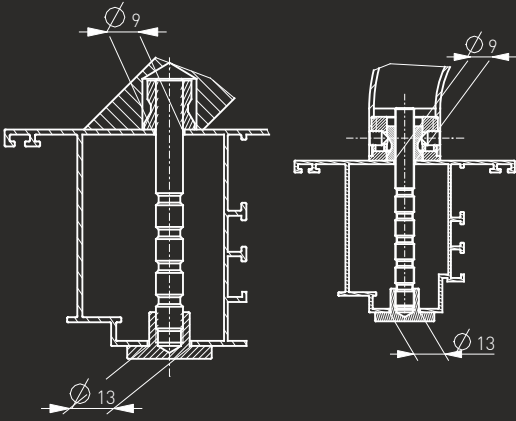
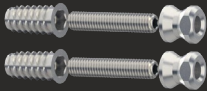
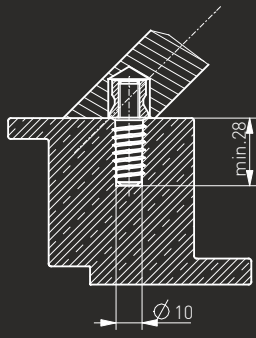
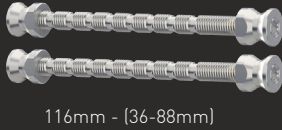
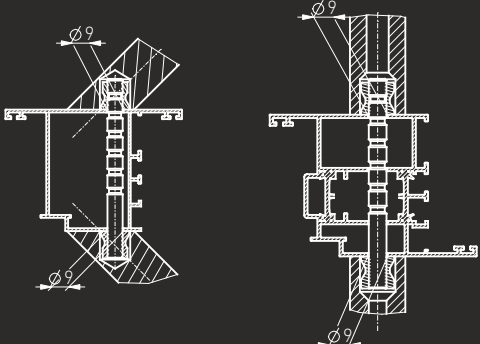

Mocowania do pochwytów ze stali nierdzewnej

Stainless steel pull handles fixing sets / Kit de fixation pour les barres de tirage en INOX / Крепление для ручек из нержавеющей стали

Mocowanie Fixing set Fixation Крепление	Opis Description Description Описание	Index -N°	Rys. techniczny Technical drawing Fiche technique Чертеж
	<p>Jednostronna turbośruba samogwintująca</p> <p>Single side self-tapping screw</p> <p>Vis autotaraudeuses pour les unilatéraux</p> <p>Саморезы для теплового профиля</p> <p>45° / 90°</p>	<p>10400003500 10400004500 10400005500</p>	
 <p>116mm - (36-102mm)</p>	<p>Jednostronne mocowanie przelotowe</p> <p>Single side inside-out fixing set</p> <p>Vis de fixation à l'envers pour les unilatéraux</p> <p>Крепление для односторонней установки</p> <p>45° / 90°</p>	<p>10400000000</p>	
	<p>Jednostronne mocowanie do drzwi drewnianych i stalowych</p> <p>Single side wooden door fixing set</p> <p>Kit de fixation pour les portes en bois pour les unilatéraux</p> <p>Одностороннее крепление к дереву</p> <p>45° / 90°</p>	<p>10400000012</p>	
 <p>116mm - (36-88mm)</p>	<p>Dwustronne mocowanie do pochwytów jednostronnych</p> <p>Double sided fixing set for single side stainless steel pull handles</p> <p>Kit de fixation pour créer un barre de tirage bilatéral de deux unilatéraux</p> <p>Двухстороннее крепление для установки односторонних ручек</p> <p>45° / 90°</p>	<p>11400000010</p>	

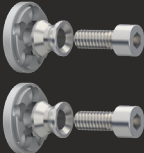
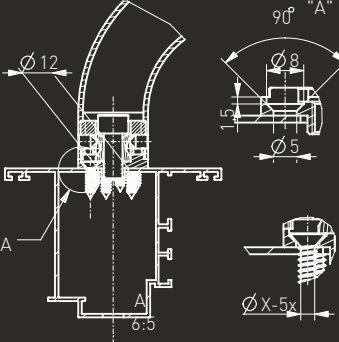
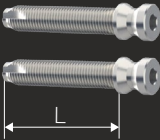
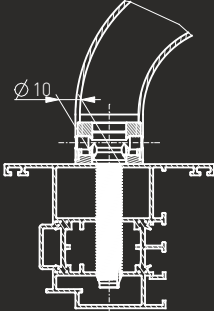
Mocowania do pochwytów aluminiowych

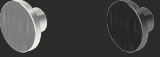
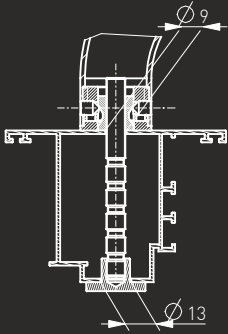
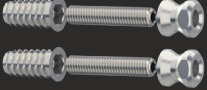
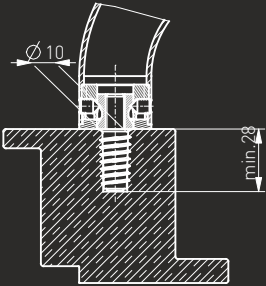
Aluminum pull handles fixing sets / Kit de fixation pour les barres de tirage en aluminium / Крепление для алюминиевых ручек

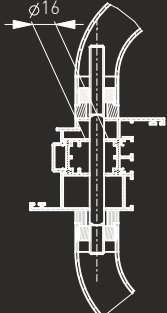
Mocowanie Fixing set Fixation Крепление	Opis Description Description Описание	Index -N°	Rys. techniczny Technical drawing Fiche technique Чертеж
	<p>Talerzyk - jednostronne mocowanie pochwytów aluminiowych</p> <p>Fixing Plate – single side fixing set for aluminum pull handles</p> <p>Plaque de fixation pour les barres unilatéraux en aluminium</p> <p>Крепление для односторонних алюминиевых ручек - пластина</p>	10400000002	
	<p>Jednostronna turbośruba samogwintująca</p> <p>Single side self-tapping screw</p> <p>Vis autotaraudeuses pour les unilatéraux</p> <p>Саморезы для теплого профиля</p>	<p>10400003500 10400004500 10400005500</p>	
 <p>116mm - (36-102mm)</p>  <p>F6 - BD F9005 - BD</p>	<p>Jednostronne mocowanie przelotowe</p> <p>Single side inside-out fixing set</p> <p>Vis de fixation à l'envers pour les unilatéraux</p> <p>Крепление для односторонней установки</p>	<p>10400000000 F6 - BD: 104F6 F9005 - BD: 104F9005 RAL9005S: 1049005S</p>	
	<p>Jednostronne mocowanie do drzwi drewnianych i stalowych</p> <p>Single side wooden door fixing set</p> <p>Kit de fixation pour les portes en bois pour les unilatéraux</p> <p>Одностороннее крепление к дереву</p>	10400000012	
 <p>120mm - (40-80mm)</p> <p>145mm - (60-93mm)</p>	<p>Śruba rzymska - dwustronne mocowanie pochwytów aluminiowych</p> <p>Roman screw - double-sided fixing set for aluminum pull handles</p> <p>Tendeur à vis - kit de fixation pour les barres de tirage bilatéraux en aluminium</p> <p>Крепление для двухсторонних алюминиевых ручек</p>	<p>11400000000 11400000010</p>	

Sprzedaż krajowa

Domestic Sales / Inlandsverkäufe / Vente nationale / Польские продажи

Tomasz Poniatowski

Dyrektor ds. Sprzedaży i Rozwoju Produktu
Kom. +48 508 186 242
tomek@medos.pl

Zbigniew Myszka

Specjalista ds. Marketingu i Handlu
Kom. +48 609 023 372
zbyszek@medos.pl

Przemysław Lasowski

Specjalista ds. Marketingu i Handlu
Kom. +48 601 277 142
przemek@medos.pl

Marcin Mątewski

Specjalista ds. Marketingu i Handlu
Kom. +48 607 236 009
marcin.m@medos.pl

Karol Przybylski

Specjalista ds. Marketingu i Handlu
Kom. +48 505 079 162
karol.p@medos.pl

Damian Stąsiek

Specjalista ds. Marketingu i Handlu
Kom. +48 693 013 401
damian.s@medos.pl

Błażej Gawroński

Specjalista ds. Marketingu i Handlu
Kom. +48 603 030 742
blazej.g@medos.pl

Waldemar Rosiński

Specjalista ds. Marketingu i Handlu
Kom. +48 601 833 175
waldemar.r@medos.pl

Dział sprzedaży zagranicznej

International sales / Internationaler Vertrieb / Ventes internationale / Отдел экспорта

Łukasz Napieralski

International Sales Director
Tel. +48 56 691 20 56
Mob. +48 515 248 576
Fax +48 56 691 20 50
lukasz@medos.pl



EN



ES



RU

Adam Szulc

Export Manager
Tel. +48 56 691 30 97
Mob. +48 609 318 148
Fax +48 56 691 20 50
as@medos.pl



EN

Bartosz Stawicki

Export Manager
Tel. +48 56 69 120 63
Mob. +48 607 173 656
Fax +48 56 691 20 50
bs@medos.pl



EN

Andrzej Mojsiewicz

Export Manager
Tel. +48 56 691 20 70
Mob. +48 502 718 288
andrzej.m@medos.pl



RU



LT

Łukasz Ferenc

Export Manager
Tel. +48 56 691 20 70
Mob. +48 601 945 737
lukasz.f@medos.pl



RU

Grażyna Kierska

Export Manager
Tel. +48 56 662 74 14
Mob. +48 607 856 654
gk@medos.pl



FR



IT



EN



ES

Maciej Zdunowski

Export Manager
Mob. +48 603 702 952
mz@medos.pl



EN



ES



Medos

Medos Paweł Buławka sp.k.
ul. Magazynowa 3
86-200 Chełmno / Polska

NIP: 875-10-02-162
REGON: 870568014

www.medos.pl

tel.: +48 (56) 56 691 20 79
fax: +48 (56) 691 20 50

03/25



Inn000564

Katalog online
Online catalog
Catalogue en ligne
Онлайн каталог

